



Shire Of Denmark A3097
2 NOV 2011 ICR11119798
COMMERCIAL DIRS
CEO
DIR OF FINANCE
DIR OF PLANNING
DIR OF INFRASTRUCTURE
DIR OF COMMUNITY
OTHER

DENMARK R.S.L. SUB-BRANCH

P.O. Box 274
DENMARK W.A. 6333
Ph: 9848 1750

Erica
Brie/Andrea
Rob

COPY

OUTLINE

The War Memorial

The Denmark RSL has been preparing for, and has received approval from the Denmark Shire, to move the War Memorial approximately 8m back on the block where it now exists.

Attach: A
Attach: B

The quoted cost of the project from Bernie Malatzky was \$52,455 plus GST with exclusions of no liability if damage to any of the heritage items.

Attach: C

The Lotteries Commission has awarded a grant of \$52,455 (plus GST) to pay for the quote from Bernie Malatzky for the works.

Attach: D

The Department of Veteran's Affairs has also awarded a grant of \$4,000 (inc GST) for contribution to the works.

Attach: E

The Denmark Shire allocated a contribution of \$11,000 inc GST in cash or kind to assist with the project.

Attach: A

Also requested at the time of submitting grant applications was the removal of the power pole on the footpath of the Memorial. The power pole will cause a safety issue with the Memorial moved back to the new location as it will be directly in front of the parade path on ANZAC Days. The removal was quoted by Western Power to be approx \$53,000. No grant has been received for this part of the project.

Attach: F

Attach: G

The RSL Hall – Strickland St

The Denmark RSL applied for a grant from the CFAP for 2011/2012 for several items with a total requested amount of \$9,523.61. An amount of \$2,000 was granted to complete a verandah over the two Bent St entrances, and to replace two doors.

Attach: H

Following a discussion with Gary Bird, DFin Denmark Shire, this amount was transferred from that project to other parts of the funding request: the relocation of the Gun currently on the corner of Bent and Strickland Sts, the building of a parapet around the gun, replacing the vegetation on the Strickland St frontage with a more suitable variety, creating a pathway from Strickland St up to the RSL Hall, and placing a cover over the gun. The cover over the gun was to be \$5,965. The other works were possibly to be covered by the Shire.

Attach: I

Attach: J
Attach: K

FUNDING IMPLICATIONS

- 2 grants have been received, both of which are to be expended on the War Memorial refurbishment.
- There is no funding for the removal of the power pole.
- The Lotteries grant covers everything if there are no breakages. Lotteries Comm have advised that if there are breakages creating further costs, go back to them for another grant to rectify.
- There is the DVA Grant of \$4,000 to be spent on the project.
- The Shire has approved a grant of \$11,000 (inc GST) for the project.
- The Shire has approved a grant of \$2,000 for the RSL Hall precinct upgrade.

\$4k DVA
\$57,000 Lotteries



DENMARK R.S.L. SUB-BRANCH

P.O. Box 274
DENMARK W.A. 6333
Ph: 9848 1750

SOLUTION

- The RSL commits the \$4,000 from DVA to the memorial, reducing the Shire's contribution to the Memorial to \$7,000.
- The Shire's CFAP \$2,000 allocation to the Denmark RSL be augmented by the \$4,000 not now being spent on the memorial. This gives \$6,000 to provide the gun cover.
- The Shire works department supplies the works required to tidy up the Strickland St frontage, build the rock parapet around the gun and supplies the brick paving for the gun site. (Note, there will be spare brick paving available from the memorial site when those works are commenced).
- The Shire approaches Western Power to remove the power pole and opts to pay the costs over a period of time.

TIME LINE

It is anticipated that works will commence as soon as possible after the 11th November, and be completed in time for ANZAC Day 2012. The builder has indicated the Memorial upgrade would not take longer than approx 2 months.

It is not known how long the Western Power works will take.

Prior to work commencing on the Memorial site, there is to be a heritage survey conducted. I spoke with and wrote to the Shire CEO on Oct 12th and requested that the survey be conducted. The advice from Dale was it would take approx a month to conduct and complete.

Attach: A

COMMENT

It is essential the works to the Memorial be completed well before ANZAC Day 2012. In order for this to occur it is necessary for commencement of the works to occur as soon as can be arranged after November 11th 2011, Remembrance Day.

Mark Davies
President,
Denmark RSL Sub-Branch

2nd November, 2011

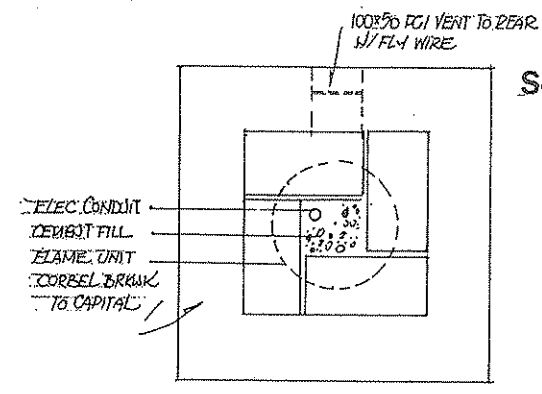

Sect. D 1:10

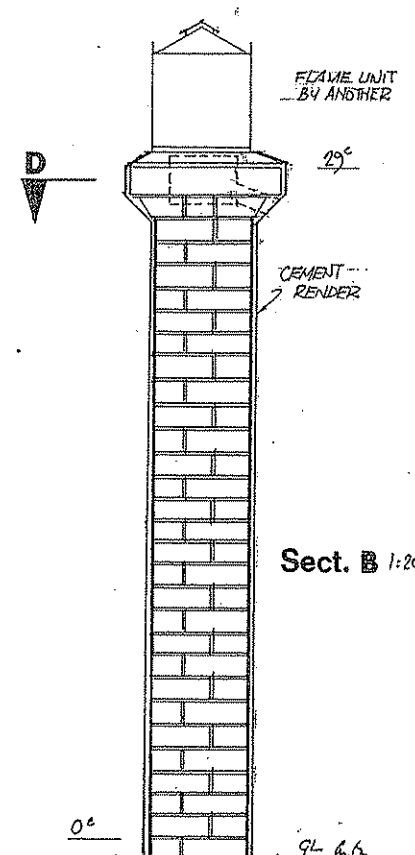

Sect. B 1:20

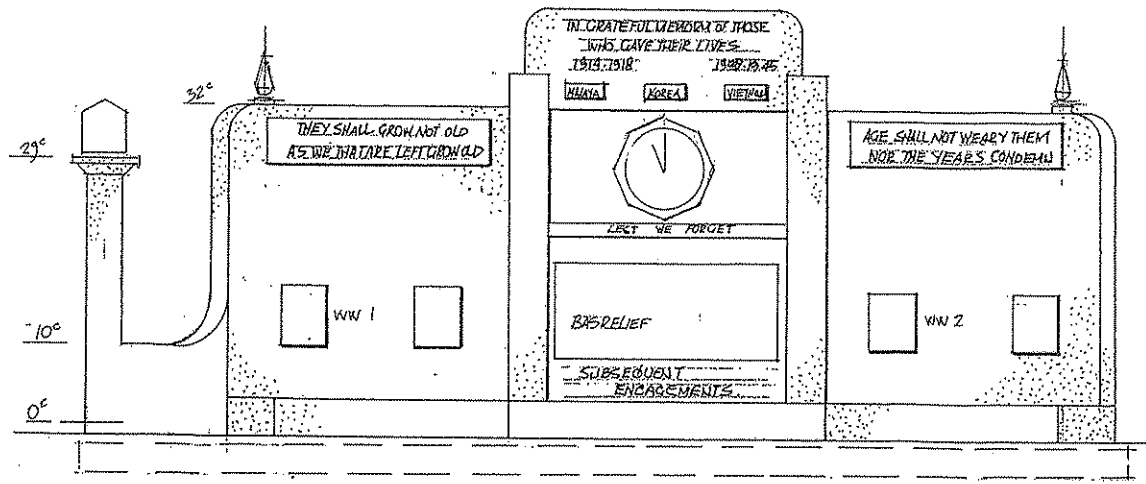

Elevation 1:50

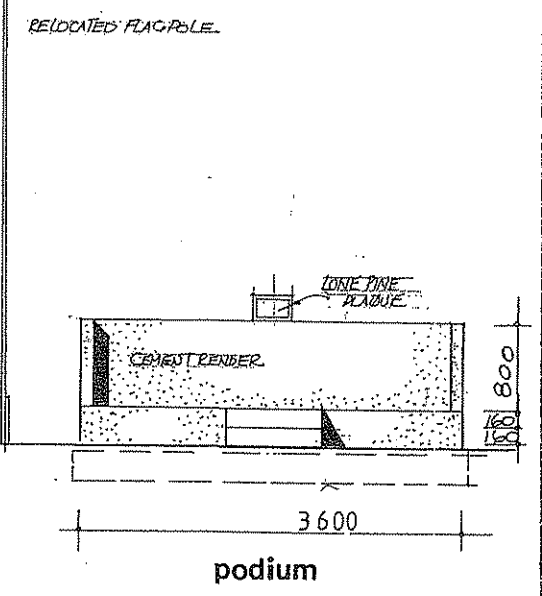

podium

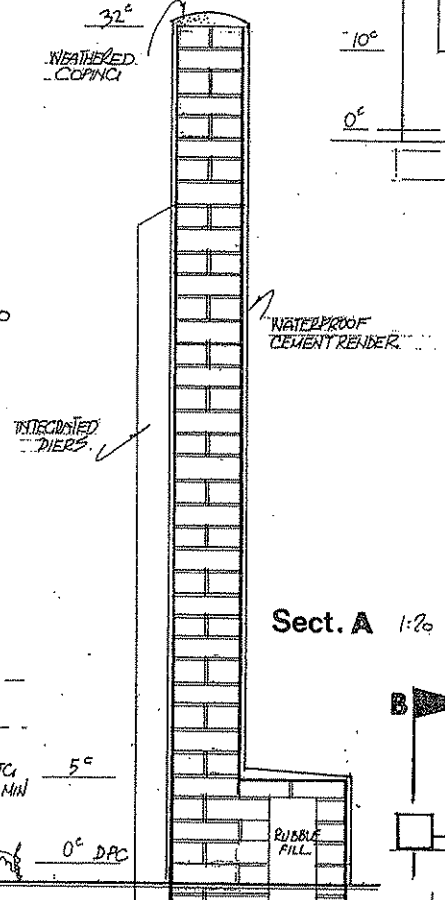

Sect. A 1:20

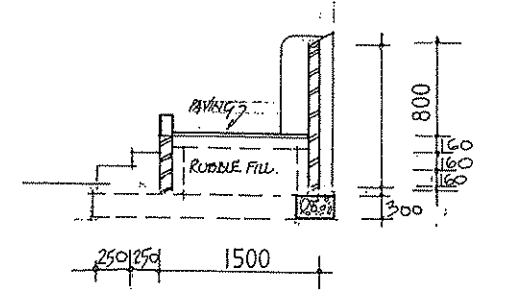

Sect. C

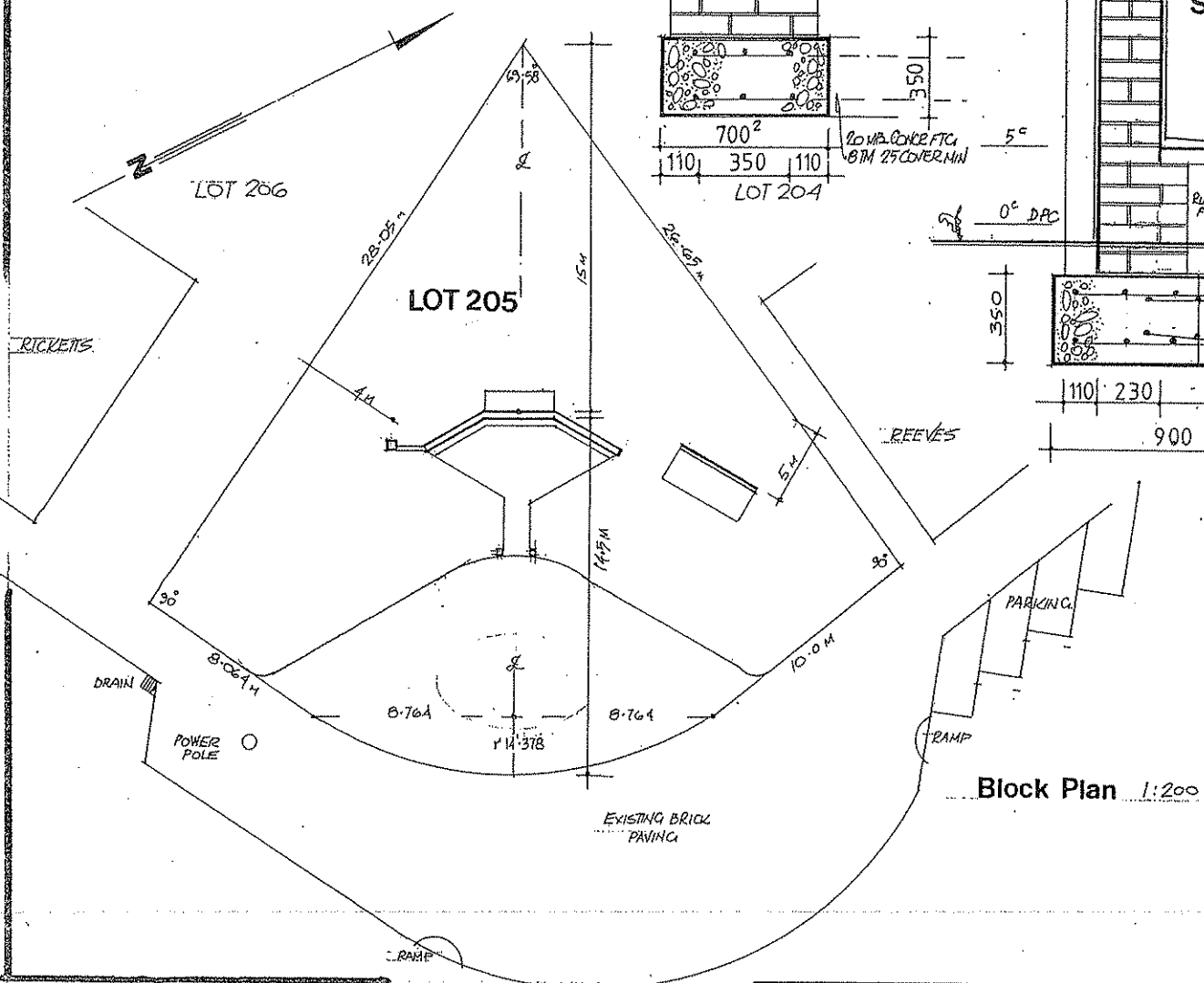

Block Plan 1:200

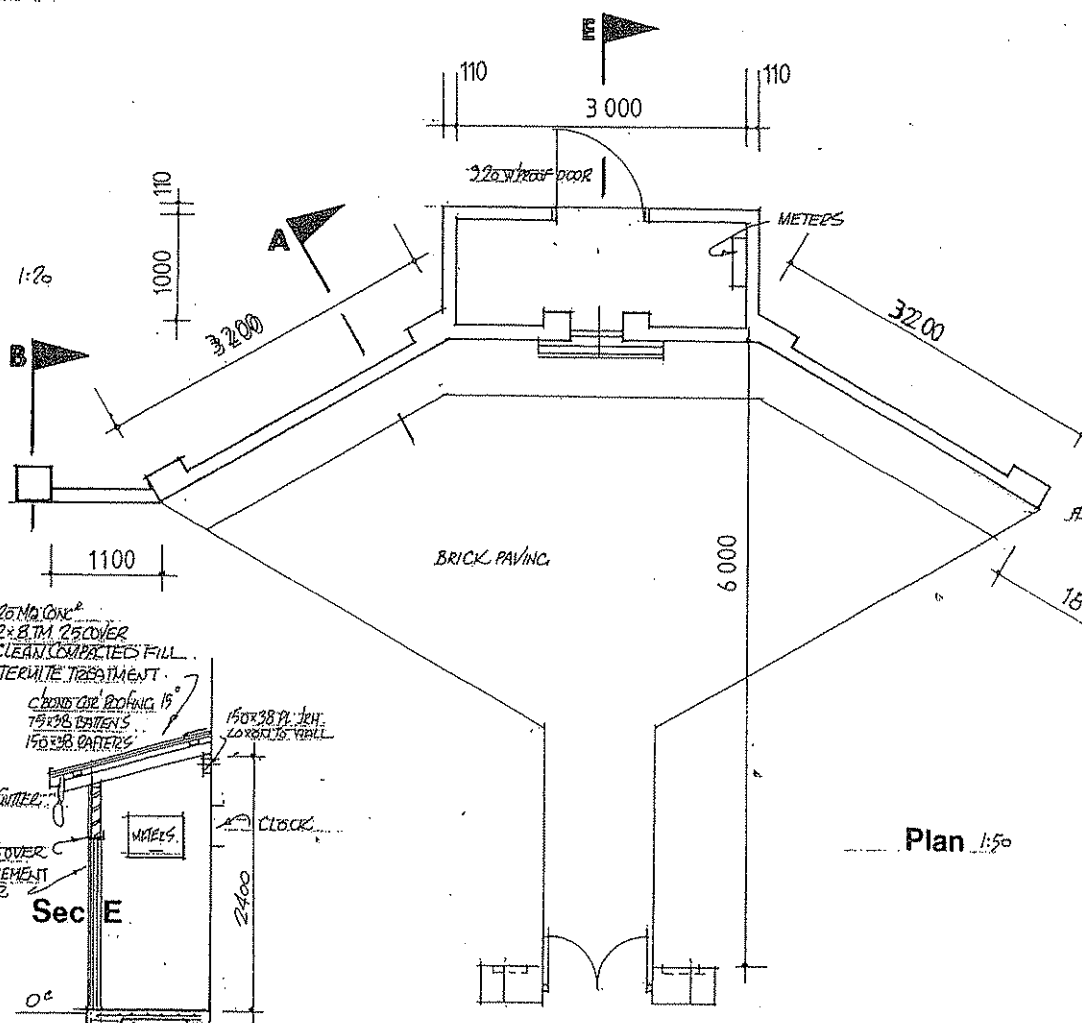

Plan 1:50

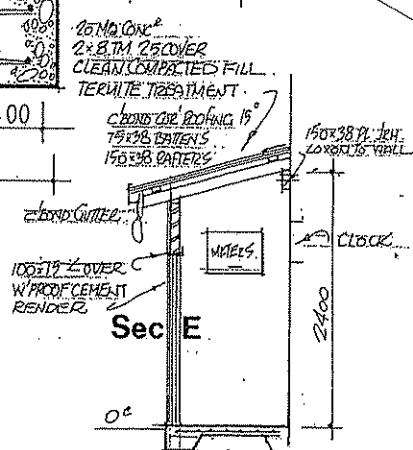

Sect. E

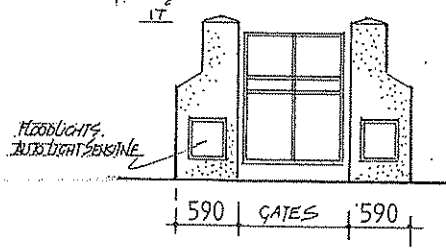

R. COOPER
 SCALE: 1:200 1:50 1:20
 PROPOSED RELOCATION & STRUCTURAL MAINTENANCE OF DENMARK WAR MEMORIAL
 DRAWING NO. 1 of 1

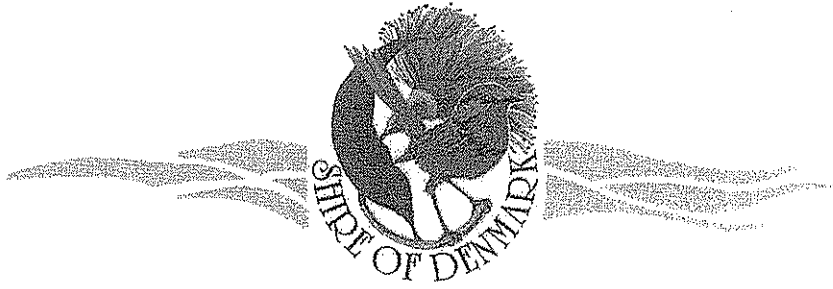

953 South Coast Highway, Denmark Western Australia 6333

Tel (08) 9848 0300 Fax (08) 9848 1985

Our Ref: DS/CT File ORG.35 / PBR.1
Enquiries: Dale Stewart

30 November 2010

Mr M Davies
 Denmark RSL Sub-Branch
 PO Box 274
 DENMARK WA 6333

Dear Mark

Re: War Memorial Relocation

In response to your request to relocate the War Memorial on Reserve 19050, I am pleased to advise that Council considered the matter at their November 2010 meetings and on the 23 November 2010 resolved as follows;

"That with respect to the Denmark RSL Sub-Branch's request to relocate the War Memorial on Reserve 19050, at Lot 205 South Coast Highway, Denmark, further back onto the same Reserve, Council;

1. Grant approval for the project subject to the retention of the existing Conifer Tree;
2. Provide letters of support for funding application/s made by the Denmark RSL Sub-Branch for the project;
3. Agree to including a financial contribution of \$11,000 (inc. GST), reflecting cash and/or in-kind services, in the 2011/2012 Municipal Budget towards the cost of the project, subject to confirmation of approval of external funding application/s and the Denmark RSL Sub-Branch confirming, by June 2011, that they have sufficient funds to complete the project in 2011/12;
4. Request that the Denmark RSL Sub-Branch undertake a Heritage Assessment/Impact Statement of the site (which can be funded in 2011/12 from the Council's financial contribution), provide a copy of it to Council and comply with any recommendations contained therein; and
5. Require the Denmark RSL Sub-Branch to lodge a Building Application noting that the need for submitting a development application and advertising is waived, given it is on Council land and that they have demonstrated significant consultation with their members.
6. Council fees are waived pursuant to Policy P100606."

Please note however that the request to have the Lone Pine tree planted within this reserve was not supported due to concerns about the size and invasiveness root nature of the tree. In this regard I invite you to liaise with Council's Supervisor Parks and Gardens, Mr Andrew Brinsden to discuss options for its location.

Celebrating 100 years of Local Government in 2011

2/..

All communications to:

Chief Executive Officer, PO Box 183, Denmark WA 6333
 Email: enquiries@denmark.wa.gov.au Website: www.denmark.wa.gov.au

..2/

In relation to the Heritage Assessment/Impact Statement I advise that contact can be made with Council's Senior Planner, Ms Cindy Simpson to discuss progressing this in the 2011/12 year, should you wish to proceed. I have received a verbal quotation from a local Heritage Architect of approximately \$500-\$1000 to undertake this task.

I wish you well with sourcing funds for this project and please let me know if you require any letters of support to include with funding applications.

Should you require further information or advice on this matter please contact the undersigned on telephone (08) 9848 0300 or email enquiries@denmark.wa.gov.au.

Yours faithfully



*Dale Stewart
Chief Executive Officer*

*cc Garry Bird, Director of Finance & Administration
cc Cindy Simpson, Senior Planner*

Bernie Malatzky

Reg. Builder 2531
PO Box 230 Denmark WA 6333
Telephone/Fax (08) 9848 3038

8th Nov 2010

The President
Denmark RSL Sub-Branch
PO Box 274
Denmark WA 6333

**Re : Denmark War Memorial Refurbishment
Quotation**

Dear Mark

Price as per your letter of the 30th Sept 2010 , except the following .

All the built in plaques will be removed with the greatest of care , but if damaged the cost of replacement is the responsibility of the RSL

The clock restoring is also the responsibility of the RSL

The cost includes all insurances required and Work Safe requirements including the fencing off of the area .

Price to carry out the work is \$57,700.00 dollars includes GST .

Thanking you for this opportunity of quoting , should you require further information please call .

Yours faithfully

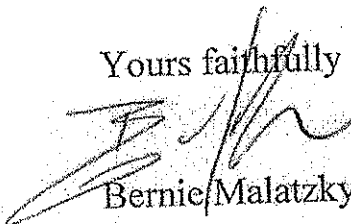

Bernie Malatzky



ATTACH D.

Please quote

Our ref: 11011073 / 420110950 / Approval

4 October 2011

Mr Mark Davies
Chief Executive Officer
Returned and Services League of Aust. WA Branch Inc - Denmark
PO Box 274
DENMARK WA 6333

Dear Mr Davies

YOUR APPROVED LOTTERYWEST GRANT, APPLICATION: 420110950

I am delighted to advise you that the Premier, the Hon Colin Barnett MLA has approved a recommendation by the Lotterywest Board for a grant of \$52,455.00 to Returned and Services League of Aust. WA Branch Inc - Denmark.

Lotterywest is pleased to be able to support your proposal.

The following content is enclosed to guide you through the rest of the grant process and help you to meet your grant obligations:

- What happens now
- Grant approval schedule
- Recipient created tax invoice
- Grant payment and acquittal information
- Acknowledging your grant
- Publication on the Lotterywest Website

Please read this information carefully as it provides important details regarding the management, payment, acquittal and publicity of your grant.

Elaine →

Process:



Saluting Their Service Commemorations Grants

Acceptance Form

I, Mr Mark Davies, President of the Denmark RSL Sub-branch, accept the offer of a grant of \$4,000 from the Minister for Veterans' Affairs. This grant will help to refurbish and relocate the Denmark War Memorial. I:

- (a) agree that the grant and any asset formed as a result of the grant will be used solely for the purpose specified in the Minister's letter of offer of grant;
- (b) agree that the grantee bears full responsibility, including liability, for all activities carried out in relation to the project;
- (c) agree to return, signed, the Acquittal Form enclosed, to the Australian Government Department of Veterans' Affairs, certifying that the full amount has been spent on the project for which the grant was made, or that any surplus funds have been remitted to the Department. This form should be returned to the Department no later than **31 March 2012**;
- (d) agree to provide the Department of Veterans' Affairs in writing by the date referred to in (c) above the reason the funds cannot be acquitted by the due date, a request for the project timeframe to be extended (for consideration by the Department) and the date by which the acquittal will be provided;
- (e) agree to retain all records relating to this grant, and the project, for which it was awarded for a period no less than two years from the date of the Minister's letter of offer;
- (f) agree to provide the Department of Veterans' Affairs with a photograph or copy of anything produced as a result of the grant (eg, books, orders of service, etc) and that these may be used, where appropriate, by the Department for commemorative and promotional purposes in its publications, including websites and brochures;
- (g) agree to acknowledge that the project is supported by funding from the Australian Government under the *Saluting Their Service* Commemorations program;
- (h) agree to disclosure of the recipient's name and details of the project as required under Commonwealth Government grant publication requirements on the Department of Veterans' Affairs website for at least two years, in media releases, letters announcing the grant to Members of the Parliament of Australia, the Australian National Audit Office and as required to meet Government accountability requirements;
- (i) agree to attempt settlement of any dispute by negotiation with the Department of Veterans' Affairs before resorting to external dispute resolution processes;
- (j) note that this grant must be acquitted before future grants can be accepted;

ATTACH F.

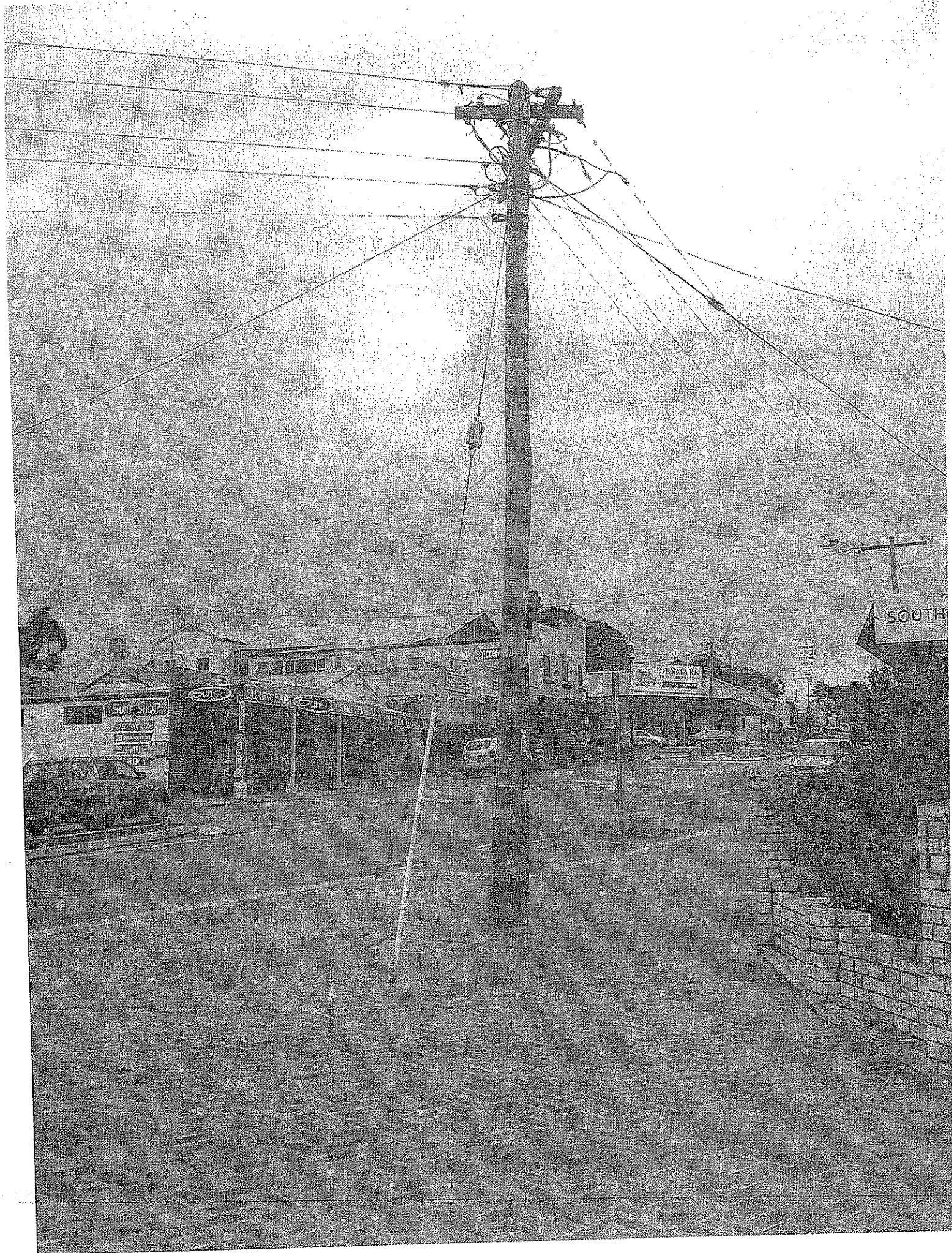



Your Ref:
Our Ref: SP033318
Enquiries: Customer Contact Centre
Telephone 13 10 87
Fax: 9225 2073

Western Power
Connections Manager
Locked Bag 2520
PERTH, WA 6001
Electricity Networks Corporation
ABN 18 540 492 861

22 November 2010

Denmark RSL
P O Box 274
DENMARK WA 6333

Attention: Mr Mark Davies

Dear Sir,

**LOT 205 SOUTH COAST HIGHWAY, DENMARK
WESTERN POWER REF: SP033318**

We acknowledge your request for a quote for the above project.

The following is an estimated cost, based on a desktop review of your requirements and the existing electrical network.

ESTIMATE

The estimated cost of your project to satisfy your request is \$52,513.00

Please note the following important information about this estimated cost:

- It is an indicative figure only, to assist you to plan and make decisions about your project.
- The final quoted cost may be higher or lower than this estimate. In some cases, final quotes are significantly higher than estimates, because of ground conditions and other impediments identified during the site visit and / or fluctuations in the cost of materials and labour etc.
- This estimated cost is non-binding.
- There is no charge for providing this estimate.
- Environmental, heritage and land development issues have not been considered in this estimate.
- The estimate is subject to the Distribution Works Terms and Conditions.



953 South Coast Highway, Denmark Western Australia 6333

Tel. (08) 9848 0300 Fax (08) 9848 1985

Our Ref: OCR1177735 File: PBR.10.A

Your Ref:

Enquiries: Jen Langridge

6th July 2011

DENMARK RSL SUB-BRANCH

PO BOX 274

DENMARK WA 6333

Dear Mr Davies

Re: Community Financial Assistance Program 2011/2012.

Thank you for your recent application for financial assistance from the Shire of Denmark Community Financial Assistance Program.

Your application has been considered by the Community Financial Assistance Program Committee and the Shire of Denmark and it is with pleasure I advise your application has been approved for the following purpose and amount;

Denmark RSL Sub-Branch: \$2,000.00

Purchase item details: Building improvements/maintenance

Generally these funds are paid upon completion of the project and the submission of an invoice to Council for the approved sum. Please note that these funds need to be expended during the course of the 2011/12 financial year or a new application will need to be submitted to carry the funding over into 2012/13.

Please note the attached guidelines for the Community Financial Assistance Grants Program, specifically the requirement to submit a completed Acquittal Form by 31 May 2012.

If you have any difficulties in completing your project, or any other issue, I would urge you to advise Council at the earliest opportunity.

On behalf of Council, I would like to wish you every success with your project and please do not hesitate to contact myself on telephone (08) 9848 0300 or email enquiries@denmark.wa.gov.au if you have any queries regarding this matter.

Celebrating 100 years of Local Government in 2011

All communications to:

Chief Executive Officer, PO Box 183, Denmark WA 6333

enquiries@denmark.wa.gov.au Website: www.denmark.wa.gov.au

AMICA I

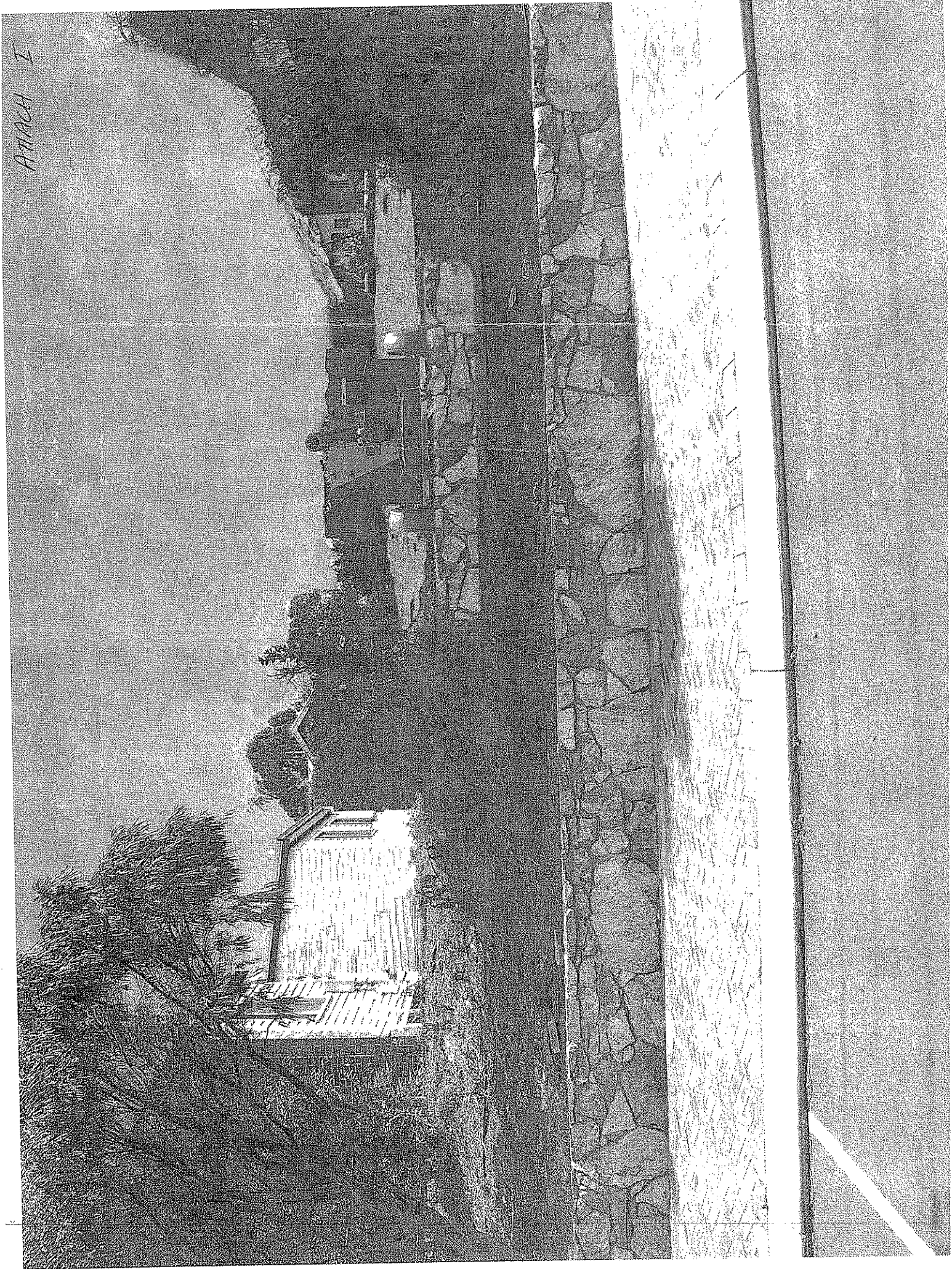

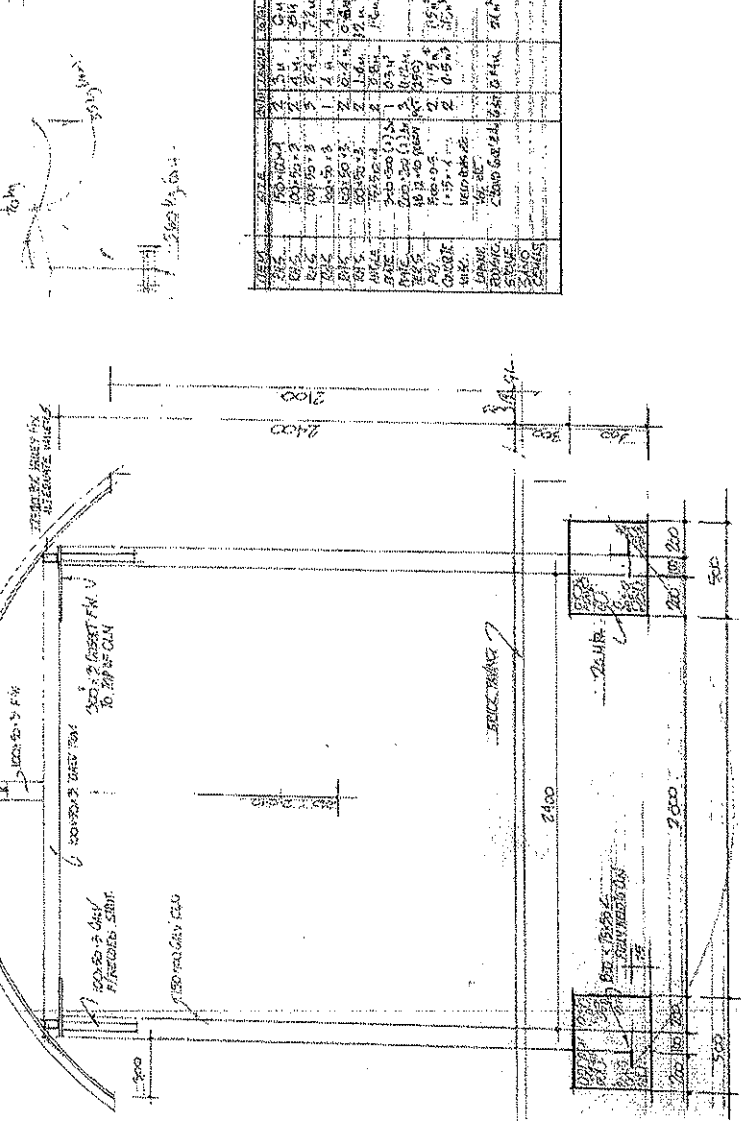
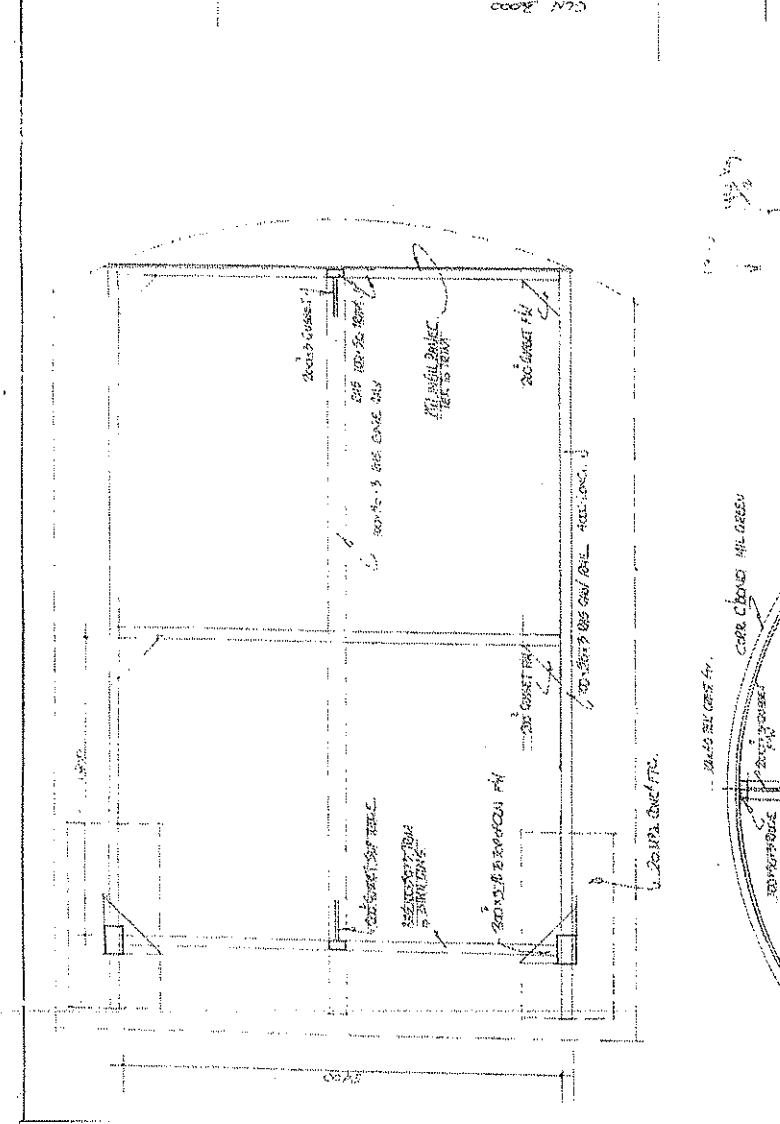
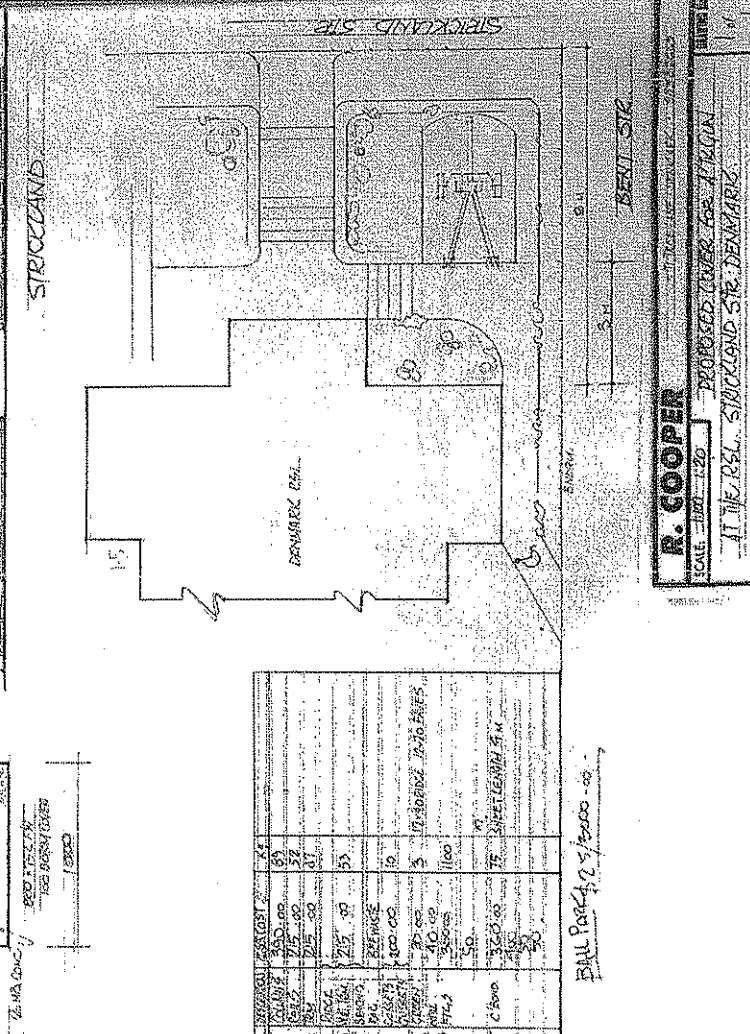
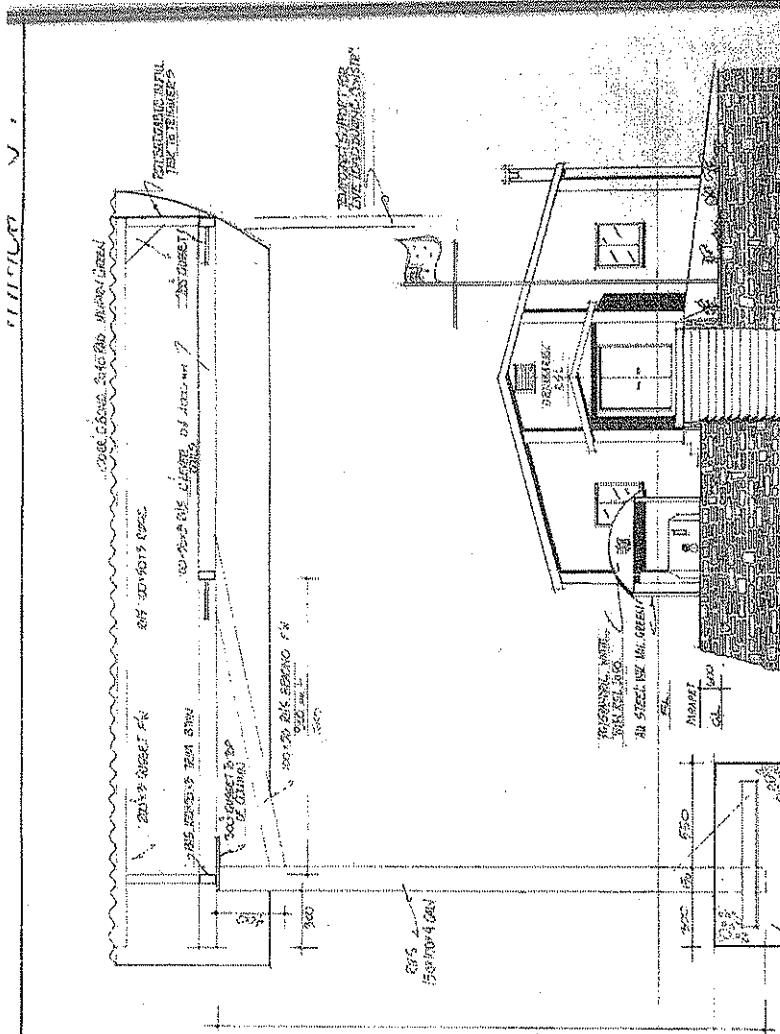

ITEM	QTY	UNIT	PRICE	TOTAL	REMARKS
1	1	sq. ft.	1.00	1.00	CONCRETE
2	1	sq. ft.	1.00	1.00	CONCRETE
3	1	sq. ft.	1.00	1.00	CONCRETE
4	1	sq. ft.	1.00	1.00	CONCRETE
5	1	sq. ft.	1.00	1.00	CONCRETE
6	1	sq. ft.	1.00	1.00	CONCRETE
7	1	sq. ft.	1.00	1.00	CONCRETE
8	1	sq. ft.	1.00	1.00	CONCRETE
9	1	sq. ft.	1.00	1.00	CONCRETE
10	1	sq. ft.	1.00	1.00	CONCRETE
11	1	sq. ft.	1.00	1.00	CONCRETE
12	1	sq. ft.	1.00	1.00	CONCRETE
13	1	sq. ft.	1.00	1.00	CONCRETE
14	1	sq. ft.	1.00	1.00	CONCRETE
15	1	sq. ft.	1.00	1.00	CONCRETE
16	1	sq. ft.	1.00	1.00	CONCRETE
17	1	sq. ft.	1.00	1.00	CONCRETE
18	1	sq. ft.	1.00	1.00	CONCRETE
19	1	sq. ft.	1.00	1.00	CONCRETE
20	1	sq. ft.	1.00	1.00	CONCRETE
21	1	sq. ft.	1.00	1.00	CONCRETE
22	1	sq. ft.	1.00	1.00	CONCRETE
23	1	sq. ft.	1.00	1.00	CONCRETE
24	1	sq. ft.	1.00	1.00	CONCRETE
25	1	sq. ft.	1.00	1.00	CONCRETE
26	1	sq. ft.	1.00	1.00	CONCRETE
27	1	sq. ft.	1.00	1.00	CONCRETE
28	1	sq. ft.	1.00	1.00	CONCRETE
29	1	sq. ft.	1.00	1.00	CONCRETE
30	1	sq. ft.	1.00	1.00	CONCRETE
31	1	sq. ft.	1.00	1.00	CONCRETE
32	1	sq. ft.	1.00	1.00	CONCRETE
33	1	sq. ft.	1.00	1.00	CONCRETE
34	1	sq. ft.	1.00	1.00	CONCRETE
35	1	sq. ft.	1.00	1.00	CONCRETE
36	1	sq. ft.	1.00	1.00	CONCRETE
37	1	sq. ft.	1.00	1.00	CONCRETE
38	1	sq. ft.	1.00	1.00	CONCRETE
39	1	sq. ft.	1.00	1.00	CONCRETE
40	1	sq. ft.	1.00	1.00	CONCRETE
41	1	sq. ft.	1.00	1.00	CONCRETE
42	1	sq. ft.	1.00	1.00	CONCRETE
43	1	sq. ft.	1.00	1.00	CONCRETE
44	1	sq. ft.	1.00	1.00	CONCRETE
45	1	sq. ft.	1.00	1.00	CONCRETE
46	1	sq. ft.	1.00	1.00	CONCRETE
47	1	sq. ft.	1.00	1.00	CONCRETE
48	1	sq. ft.	1.00	1.00	CONCRETE
49	1	sq. ft.	1.00	1.00	CONCRETE
50	1	sq. ft.	1.00	1.00	CONCRETE
51	1	sq. ft.	1.00	1.00	CONCRETE
52	1	sq. ft.	1.00	1.00	CONCRETE
53	1	sq. ft.	1.00	1.00	CONCRETE
54	1	sq. ft.	1.00	1.00	CONCRETE
55	1	sq. ft.	1.00	1.00	CONCRETE
56	1	sq. ft.	1.00	1.00	CONCRETE
57	1	sq. ft.	1.00	1.00	CONCRETE
58	1	sq. ft.	1.00	1.00	CONCRETE
59	1	sq. ft.	1.00	1.00	CONCRETE
60	1	sq. ft.	1.00	1.00	CONCRETE
61	1	sq. ft.	1.00	1.00	CONCRETE
62	1	sq. ft.	1.00	1.00	CONCRETE
63	1	sq. ft.	1.00	1.00	CONCRETE
64	1	sq. ft.	1.00	1.00	CONCRETE
65	1	sq. ft.	1.00	1.00	CONCRETE
66	1	sq. ft.	1.00	1.00	CONCRETE
67	1	sq. ft.	1.00	1.00	CONCRETE
68	1	sq. ft.	1.00	1.00	CONCRETE
69	1	sq. ft.	1.00	1.00	CONCRETE
70	1	sq. ft.	1.00	1.00	CONCRETE
71	1	sq. ft.	1.00	1.00	CONCRETE
72	1	sq. ft.	1.00	1.00	CONCRETE
73	1	sq. ft.	1.00	1.00	CONCRETE
74	1	sq. ft.	1.00	1.00	CONCRETE
75	1	sq. ft.	1.00	1.00	CONCRETE
76	1	sq. ft.	1.00	1.00	CONCRETE
77	1	sq. ft.	1.00	1.00	CONCRETE
78	1	sq. ft.	1.00	1.00	CONCRETE
79	1	sq. ft.	1.00	1.00	CONCRETE
80	1	sq. ft.	1.00	1.00	CONCRETE
81	1	sq. ft.	1.00	1.00	CONCRETE
82	1	sq. ft.	1.00	1.00	CONCRETE
83	1	sq. ft.	1.00	1.00	CONCRETE
84	1	sq. ft.	1.00	1.00	CONCRETE
85	1	sq. ft.	1.00	1.00	CONCRETE
86	1	sq. ft.	1.00	1.00	CONCRETE
87	1	sq. ft.	1.00	1.00	CONCRETE
88	1	sq. ft.	1.00	1.00	CONCRETE
89	1	sq. ft.	1.00	1.00	CONCRETE
90	1	sq. ft.	1.00	1.00	CONCRETE
91	1	sq. ft.	1.00	1.00	CONCRETE
92	1	sq. ft.	1.00	1.00	CONCRETE
93	1	sq. ft.	1.00	1.00	CONCRETE
94	1	sq. ft.	1.00	1.00	CONCRETE
95	1	sq. ft.	1.00	1.00	CONCRETE
96	1	sq. ft.	1.00	1.00	CONCRETE
97	1	sq. ft.	1.00	1.00	CONCRETE
98	1	sq. ft.	1.00	1.00	CONCRETE
99	1	sq. ft.	1.00	1.00	CONCRETE
100	1	sq. ft.	1.00	1.00	CONCRETE

R. COOPER
 ARCHITECT
 1111 1/2 ST. S. DENVER, CO. 80202
 PHONE: 333-1111
 FAX: 333-1111
 PROPOSED COVER FOR ATRION
 AT THE BSL STRICKLAND STR. DENVER, CO.

BSL Park 40 3/2000 -00

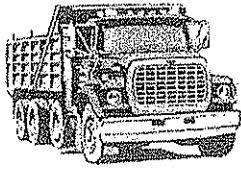

PLANT WELDING

PO BOX 175
DENMARK WA 6333
PH: (08) 9848 1288
MOB: 0408 954 100

QUOTE TO FABRICATE COVER FOR GUN AT RSM HALL
ON STRICILLAND STREET DENMARK
ALL MATERIALS INCLUDING CONCRETE + LABOUR
ESTIMATED AT \$4786.56 + GST

ROB PLANT

A handwritten signature in black ink, appearing to read 'Rob Plant', with a long horizontal flourish extending to the right.



Premier of Western Australia

Our ref: 24-69612/EB

Mr Mark Davies
President
Denmark RSL Sub-Branch
PO Box 274
DENMARK WA 6333

Dear Mr Davies

Thank you for your letter dated 14 February 2011 seeking my assistance in having a power pole and associated infrastructure removed from the Denmark War Memorial site at Western Power's cost. I apologise for the delay in responding.

I appreciate this upgrade will be of great significance to both the Denmark RSL Sub-Branch and the local community, especially as we approach the commemoration of the Anzac Centenary.

Western Power is required to ensure that it recovers the cost of all customer requested projects across all sectors of the community. While I appreciate the difficulty involved in funding this work, Western Power receives many requests to subsidise projects and it is difficult for it to meet all these worthwhile initiatives. However, Western Power has informed me that it is able to offer an instalment payment arrangement, which I am hopeful may assist in some way to enable you to progress the project.

I am advised that the estimate provided by Western Power has been extensively reviewed and accurately reflects the costs associated with undertaking this work.

Should you wish to proceed with the project or if you have any further queries relating to this matter, I am informed that the contact person from Western Power is Robyn Preston on 9425 5036.

Thank you again for your letter.

Yours sincerely

A handwritten signature in black ink, appearing to read 'Colin Barnett'.

Colin Barnett MLA
PREMIER

23 JUN 2011

